



CRE

DIRECT OPERATED PRESSURE CONTROL VALVE WITH ELECTRIC PROPORTIONAL CONTROL

SERIES 20

CARTRIDGE TYPE

p max 350 bar
Q max 1,5 l/min

SEAT DIMENSIONS: D-10A

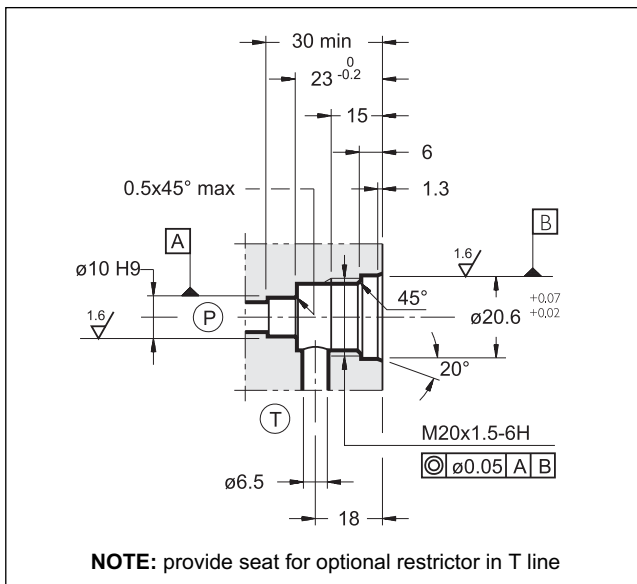

PERFORMANCES

(obtained with mineral oil with viscosity of 36 cSt at 50°C and electronic control card)

Maximum operating pressure: - P port - T port	bar	350 2
Minimum controlled pressure	see Δp-Q diagram	
Nominal flow Maximum flow	l/min	0,5 1,5
Step response	see paragraph 5	
Hysteresis (with PWM 200 Hz)	% of p nom	< 5%
Repeatability	% of p nom	< ±1,5%
Electrical characteristic	see paragraph 4	
Ambient temperature range	°C	-20 / +50
Fluid temperature range	°C	-20 / +80
Fluid viscosity range	cSt	10 + 400
Fluid contamination degree	According to ISO 4406:1999 class 18/16/13	
Recommended viscosity	cSt	25
Mass	kg	0,54

OPERATING PRINCIPLE

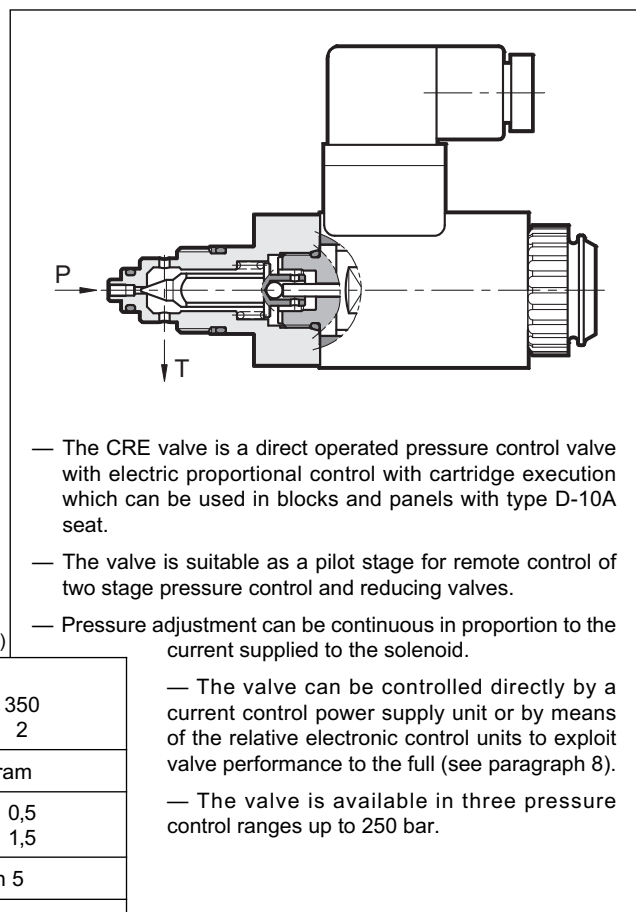

HYDRAULIC SYMBOL

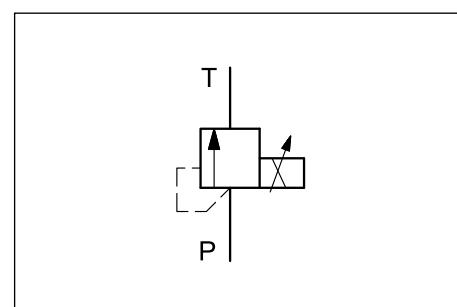

1 - IDENTIFICATION CODE

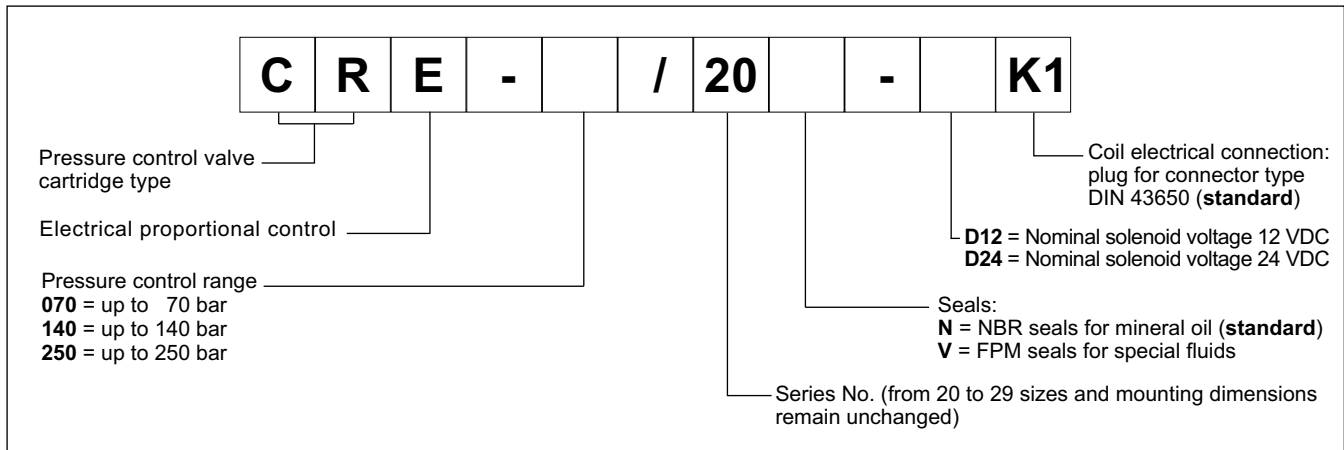

2 - CHARACTERISTIC CURVES

(measured with viscosity of 36 cSt at 50°C)

Typical control curves according to the current supplied to the solenoid, measured with input flow rate $Q=0,5$ l/min. The curves have been obtained without any hysteresis and linearity compensation and they are measured without any backpressure in T.

PRESSURE CONTROL $p = f(I)$

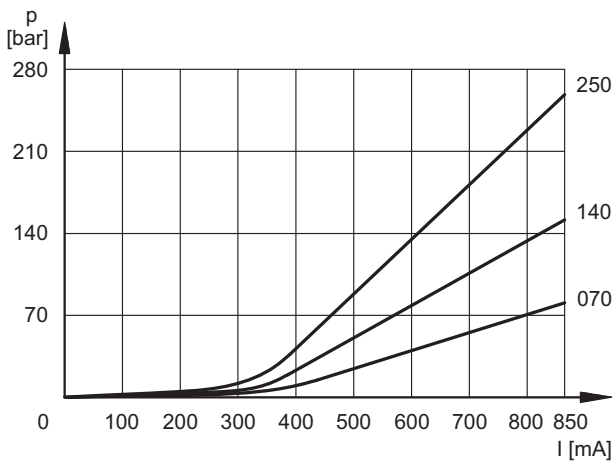

MINIMUM CONTROLLED PRESSURE $p_{min} = f(Q)$

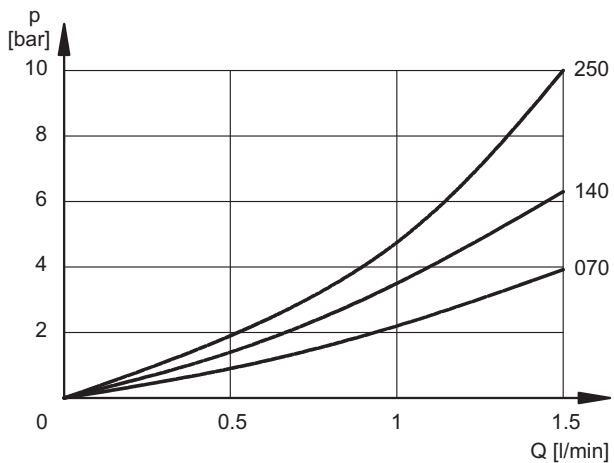

PRESSURE VARIATION $p_{max} = f(Q)$

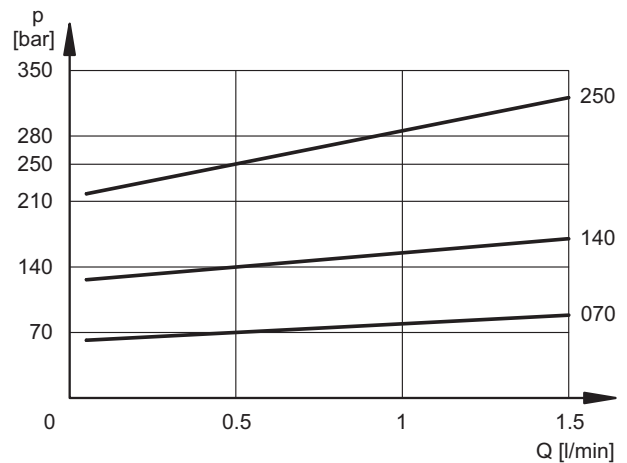

3 - HYDRAULIC FLUIDS

Use mineral oil-based hydraulic fluids HL or HM type, according to ISO 6743-4. For these fluids, use NBR seals (code N).

For fluids HFDR type (phosphate esters) use FPM seals (code V).

For the use of other fluid types such as HFA, HFB, HFC, please consult our technical department.

Using fluids at temperatures higher than 80 °C causes a faster degradation of the fluid and of the seals characteristics.

The fluid must be preserved in its physical and chemical characteristics.

4 - ELECTRICAL CHARACTERISTICS

Proportional solenoid

The proportional solenoid comprises two parts: tube and coil.

The tube, screwed to the valve body, contains the armature which is designed to maintain friction to a minimum thereby reducing hysteresis.

The coil is mounted on the tube secured by means of a lock nut and can be rotated through 360° depending on installation clearances.

NOMINAL VOLTAGE	V DC	12	24
RESISTANCE (at 20°C)	Ω	3.66	16.6
MAXIMUM CURRENT	A	1.9	0.85
DUTY CYCLE		100%	
ELECTROMAGNETIC COMPATIBILITY (EMC)	According to 2014/30/EU		
CLASS OF PROTECTION Atmospheric agents (IEC EN 60529)	IP65		

5 - STEP RESPONSE

(obtained with mineral oil with viscosity of 36 cSt at 50°C and electronic control card)

Step response is the time taken for the valve to reach 90% of the set pressure value following a step change of reference signal.

The table illustrates typical step response times measured with a valve of pressure range up to 140 bar and with input flow rate Q = 0,5 l/min.

REFERENCE SIGNAL STEP	0 → 100%	100 → 0%
Step response [ms]	80	40

6 - INSTALLATION

We recommend to install the CRE valve either in horizontal position, or vertical position with the solenoid downward. If the valve is installed in vertical position and with the solenoid upward, you must consider possible variations of the minimum controlled pressure, if compared to what is indicated in paragraph 2.

Ensure that there is no air in the hydraulic circuit. In particular applications, it can be necessary to vent the air entrapped in the solenoid tube, by using the apposite drain screw in the solenoid tube. Ensure that the solenoid tube is always filled with oil (see par. 7). At the end of the operation, make sure of having screwed correctly the drain screw.

Connect the valve T port directly to the tank. **Add any backpressure value detected in the T line to the controlled pressure value. Maximum admissible backpressure in the T line, under operational conditions, is 2 bar.**

7 - OVERALL AND MOUNTING DIMENSIONS

dimensions in mm

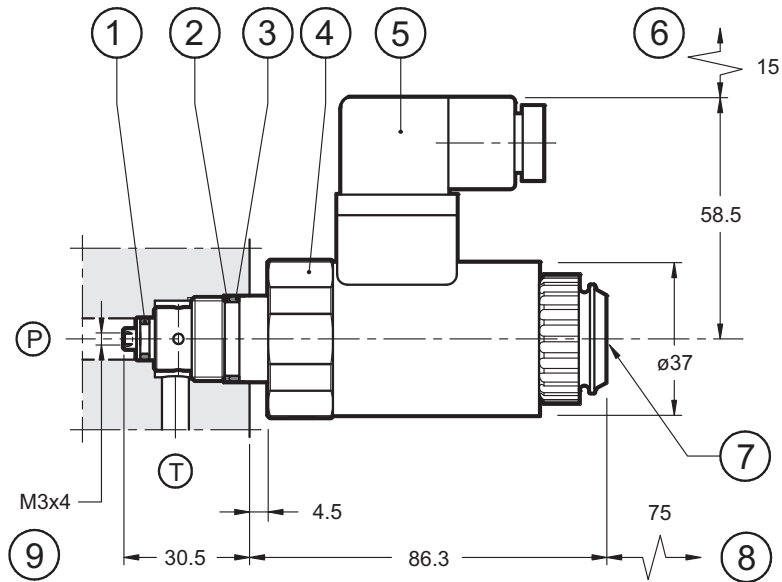

NOTE: at the first start up, or after a long period of no use, it is necessary to vent the air through the breather (7) placed at the end of the solenoid tube.

* The 4,5 mm dimension can be reduced to 0,5 mm by increasing the axial dimensions of the D-10A seat of 4 mm.

1	OR type 2025 (6.07x1.78)
2	PARBAK type 8-017 (18.01x1.14x1.35)
3	OR type 2068 (17.17x1.78)
4	Hex: spanner 36, torque 45 ± 50 Nm
5	EN 175301-803 (ex DIN 43650) electric connector
6	Connector removal space
7	Breather (male hexagonal spanner 4)
8	Coil removal space
9	Seat for optional calibrated flow restrictor

8 - ELECTRONIC CONTROL UNITS

EDC-112	for solenoid 24V DC	plug version	see cat. 89 120
EDC-142	for solenoid 12V DC		
EDM-M112	for solenoid 24V DC	DIN EN 50022 rail mounting	see cat. 89 251
EDM-M142	for solenoid 12V DC		